

material

igus® solutions for material flow, automated warehouses, logistics and conveyor technology

plastics for longer life® ...igus

handling

... www.igus.eu/materialhandling ...

Reduce cost...



Christian Strauch

Industry Manager
Material Handling
Phone: +49 2203 9649 7208
e-mail: cstrauch@igus.de

Energy efficient, fail-safe, lightweight, affordable and quick to install – igus® plastics solutions for intra logistics.

Logistics is growing thanks to the fast-growing online trading. Processes are becoming more complicated and faster. Logistics is growing thanks to the fast-growing online trading. Processes are becoming more complicated and faster. An important role is played here by the components and machines that are reliable in operation and never or rarely are in need of service.

igus® offers plastics solutions for the safe guidance of energy and other media, and for the maintenance- and lubrication-free use of plain bearings made of plastic. We test all the products under practical conditions in the largest test lab of its kind in Cologne. More than 200,000 customers rely on plastics solutions from igus® worldwide.

The advantages of igus® products for the material handling field:

e-chains®:

- For long travels up to 800 m
- For high dynamics - 7 m/s speed, 10 m/s² acceleration
- Maintenance-free
- High service life
- Ready to install, fast delivery

chainflex® cables:

- Low-temperature-flexible down to -40°C
- Specifically designed for highly dynamic movements in energy chains
- Special bus cables for extreme loads
- 36 month guarantee for all chainflex® cables

iglidur® bearings:

- Dry running and lubrication-free
- High edge loads and surface pressures up to 200 MPa
- Lightweight
- Maintenance-free

Our online tools also enable you to reduce **process costs**. igus® delivers from **stock in 24-48 hours!** And you can visit our industry website for more information

 www.igus.eu/materialhandling

I look forward to speaking to you.

... .. improve technology ...



... with motion plastics® from igus® ...

igus® products for ...

... the Intra logistics

Maintenance-free plastic products

- 1 e-chains® series for virtually all applications.
System E4.1
www.igus.eu/E4.1
- 2 Electronic monitoring module.
PPDS system
www.igus.eu/PPDS
- 3 Troughs for long travels.
Super-aluminium
www.igus.eu/alu-guide
- 4 For vertical applications with low system height.
liftband
www.igus.eu/liftband
- 5 Harnessed systems in 3-10 days.
readychains®
www.igus.eu/readychain
- 6 Heavy duty bearings for extremely high loads.
iglidur® Q2
www.igus.eu/Q2
- 7 Rotary motion in the most confined space.
twisterband
www.igus.eu/twisterband
- 8 Lubrication-free slewing ring bearings.
iglidur® PRT
www.igus.eu/PRT
- 9 Maintenance-free and lubrication-free spherical bearings igubal®
www.igus.eu/igubal
- 10 E2/000 guide trough module.
guidefast
www.igus.eu/guidefast
- 11 Long travels up to 150 m without glide rails.
guidelite & E2/000 e-chain®
www.igus.eu/guidelite
- 12 Energy efficient roller chain profile for high speeds.
System P4
www.igus.eu/P4
- 13 Intelligent conveyor chain for pick & place.
pikchain®
www.igus.eu/pikchain
- 14 Vertical energy supply system without swinging out.
guidelok slimline
www.igus.eu/GLSL-F
www.igus.eu/GLSL-P
- 15 Safe guidance of energy, data and air.
micro flizz®
www.igus.eu/microflizz
- 16 3D e-chain® and torsionable cables for robots.
triflex® R & CFROBOT
www.igus.eu/triflexR
- 17 Reduce drive power up to 75%.
E4.1 rol e-chain®
www.igus.eu/E4.1
- 18 Linear and drive technology.
drylin®
www.igus.eu/drylin
- 19 The e-chains® standard.
System E2/000
www.igus.eu/E2000
- 20 Multiple-axis joint - building blocks
robotlink®
www.igus.eu/robotlink
- 21 Reduce cable wear with the alternative to cable reel.
e-spool
www.igus.eu/e-spool
- 22 Lubrication-free iglidur® plain bearing materials.
www.igus.eu/iglidur
- 23 Magnet e-chain® for circular and vertical motion.
www.igus.eu/magsnap
- 24 Cables with the smallest radii.
www.igus.eu/chainflex

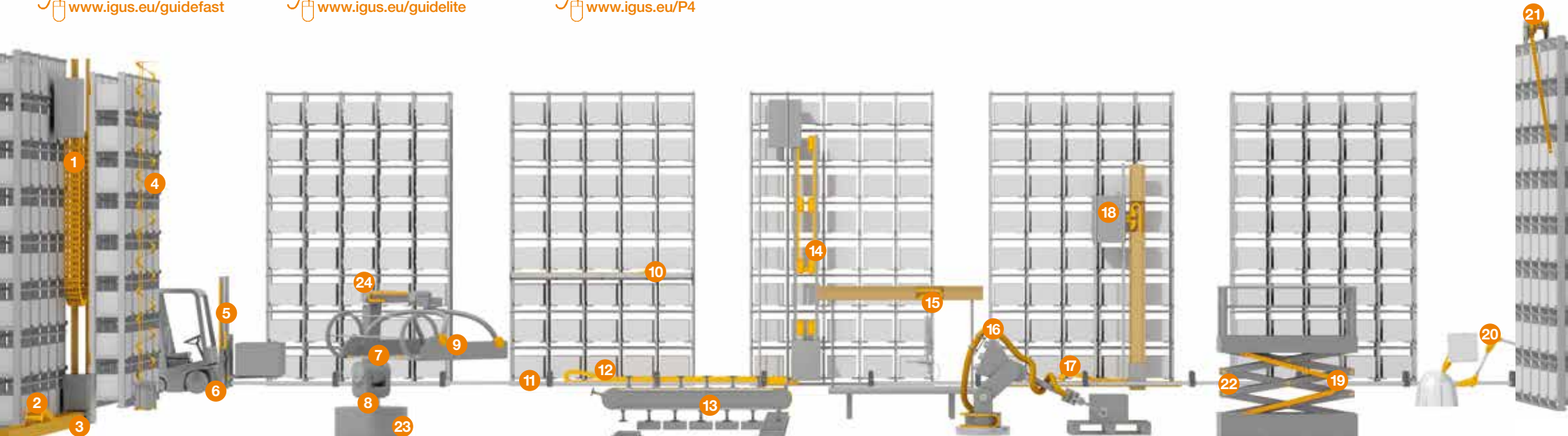

Reliable, fast, and cost-effective

... up to 50 m height

The solutions for all stacker cranes, jacks and lifts



guidelok slimline P.S

New guidelok system GLSLP.S now also for very narrow lanes.

- One-piece construction allows a straight connection of the moving end to the load suspension device
- Very compactly built, hence very well suited for narrow lanes
- Identical advantages like the predecessor GLSL.P.S.: Plug-in rails, very light, quick assembly



guidelok slimline P

Secure vertical guiding of e-chains® for very dynamic storage and retrieval systems.

- Significant savings in costs and weight when compared with a complete housing
- This also means low transport costs
- Fast, safe and easy assembly with clip-on guide rails
- Reduced noise
- Easy access for servicing
- Energy, data and other media in one system



guidelok slimline F

Secure vertical guiding of e-chains® for very dynamic storage and retrieval systems.

- Up to 7 m/s and 10 m/s²
- Up to 80% less trough required
- Saves costs and weight significantly
- For hanging systems up to 50 m
- No swinging of the e-chain®, high reliability due to the lock mechanism and guiding rails
- Faster and easier installation
- Reduced noise
- Easy access for servicing



© SSI Schäfer

Travels up to 150 m ...

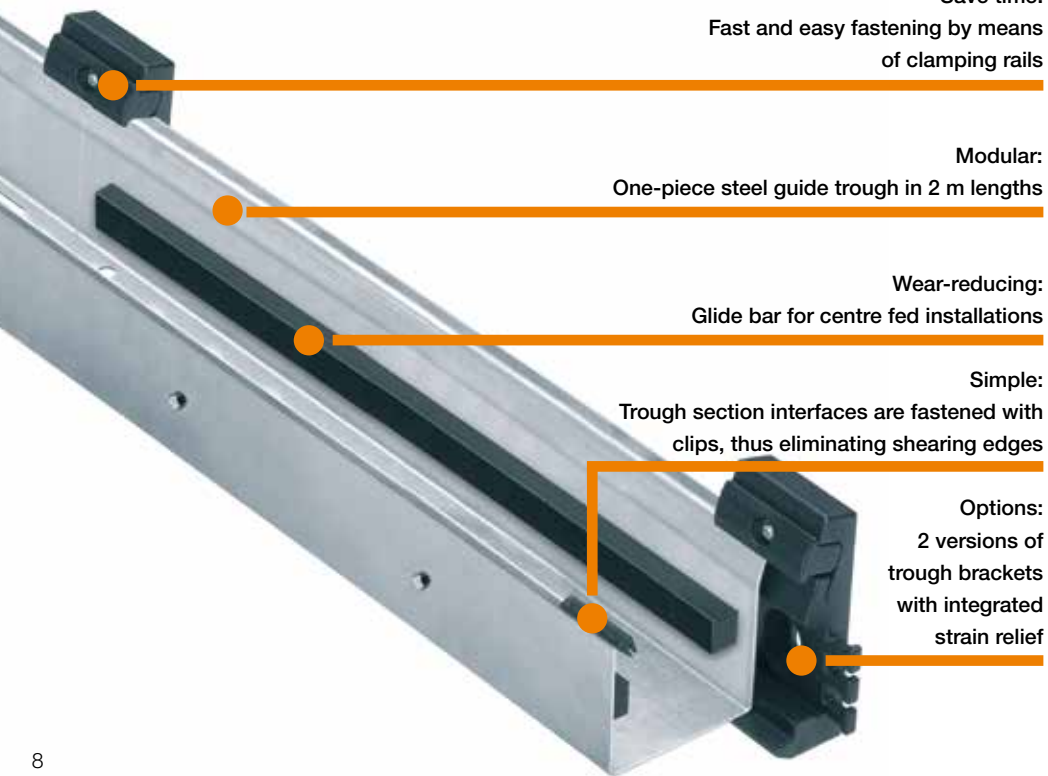

Save time:
Fast and easy fastening by means
of clamping rails

Modular:
One-piece steel guide trough in 2 m lengths

Wear-reducing:
Glide bar for centre fed installations

Simple:
Trough section interfaces are fastened with
clips, thus eliminating shearing edges

Options:
2 versions of
trough brackets
with integrated
strain relief

... quickly assembled

**guidefast trough – for crane girders
on standard indoor cranes.**

- Save up to 80% installation time
- Fits virtually any standard crane girder
- Suitable for any side-mounted application – not only on cranes
- Simplified electrical hook-up, fixed installation
- Permanently installed cable can be fixed to the trough brackets
- Less abrasion: optionally available with polymer glide bars
- Lightweight

www.igus.eu/guidefast

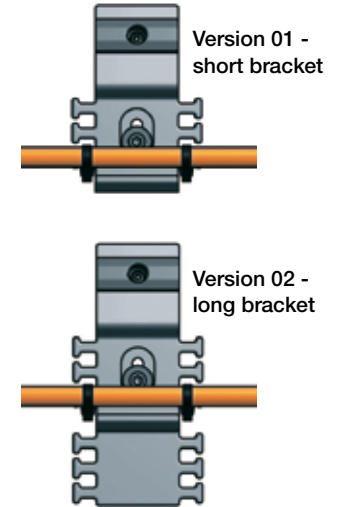

Application vertical ...



e-spool modular kit

The alternative to a cable reel. Reduce cable wear and reliably guide different media.

- No tensile load on the cables
- Different media and diameters possible in one reel
- Energy supply possible in all directions (horizontal, vertical, diagonal ... everything works with one chain)
- Space-saving, no "chain festoons"
- No lower run remains, paths remain free
- Cable diameters up to 19 mm

 www.igus.eu/e-spool



liftband

For vertical applications up to 13 m height.

- Alternative to zig-zag solution
- Lighter and smaller installation space
- Vertical applications implemented with ease
- Speeds up to 1 m/s
- Acceleration up to 2 m/s²
- Max. extension length 13 m
- Cable bend radius up to 250 mm

 www.igus.eu/liftband

... and horizontal applications

System P4

Profile roller e-chain®: for very high fill weights and speeds

- Identical pitch of the e-chain® link with or without roller
- The upper run rollers travel through the lower run rollers (not on top of each other, as was the case in previous roller chains), therefore very quiet operation
- Integrated captive roller in the side part
- Long distances (up to 800 m), high fill weights (up to 30 kg/m)
- For very long travel distances and high travel speeds up to 10 m/s
- autoglide crossbars for a safe guiding in very long travels
- Available in 4 inner heights (32, 42, 56, 80 mm)
- Large modular P4 tool box system with interior separations of the system E4
- Significant reduction of the drive power to less than 25% to move the e-chain®

 www.igus.eu/P4



micro flizz®

A system for the safe guidance of energy, data and air. Master long travels with the smallest e-chains® without failures.

- Maintenance-free alternative for bus bar
- e-chain® is guided in a special groove, no gliding on each other
- Control option via stationary switch cabinet
- Accelerations up to 50 m/s² and speeds up to 6 m/s
- Fast assembly due to pre-configured, modular system
- Less space required
- Smooth running due to ball bearings in the guide carriages
- Also with EX tested e-chain® available (upon request)
- Material rail MF06/MF08: Aluminium anodised, material rail MF10: black anodised

 www.igus.eu/microfizz



The e-chain® that holds itself.

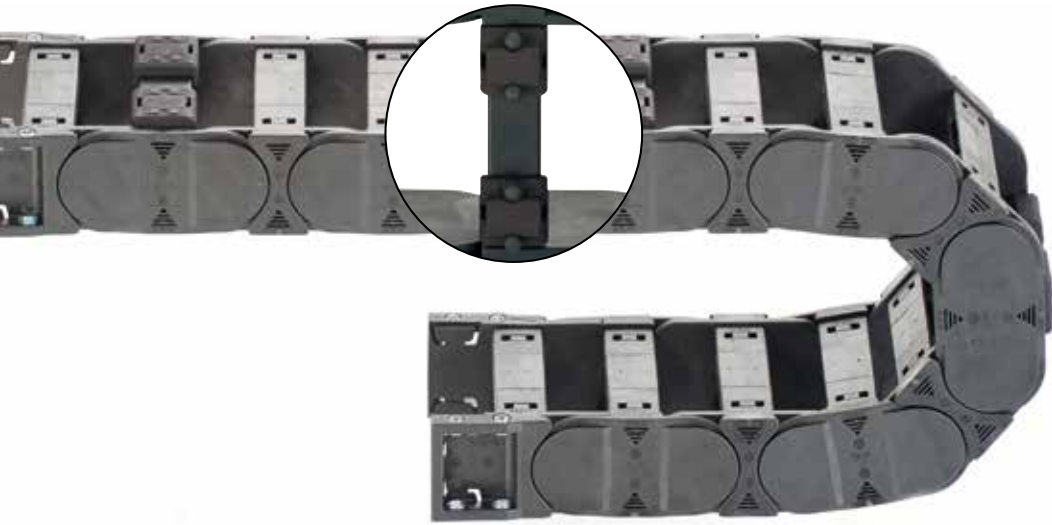

No more trough!

igus® magsnap – guide troughs superfluous.

For long vertically hanging applications where a guidance by means of guide trough is not possible for reasons of space. Magnets hold the e-chain® in the specified direction and "fix" it to a metal surface of your system, for example lifts and jacks. This prevents the e-chain® from swinging. The magsnap e-chain® is also ideal for vertical circular motion (RBR) as magnets hold the outer radius of the e-chain® onto the RBR guide trough and the e-chain® can be moved securely and quietly.

Typical application areas:

Hanging applications, such as: lifts, jacks, automatic car parking stations and vertical applications with circular movements (RBR).

- Holds the e-chain® in vertical, horizontal or circular applications in a strong position
- Quick and easy assembly
- Equipped with dampening elements for noise reduction
- Easy to retrofit

 www.igus.eu/magsnap

Magnets in the outer radius ...

... side-mounted

... hanging

... circular (RBR)







chainflex® cables ...

The special structure of igus® chainflex® cables ...







1. High-tensile core element, for durability in the dynamics
2. Optimised stranded wire structure, for the smallest radii
3. High-quality core insulation, protection against short circuits
4. Stranding in bundles with short pitch lengths, reliability through rugged construction
5. Gusset filled extruded inner jacket, long service life in long travels
6. Overall shield with optimised braiding angle, excellent EMC protection in the long-term
7. Pressure extruded, abrasion resistant outer jacket, protection in cold and abrasive environments



Servo cables: e.g. chainflex® CF29 – ideal for deep-freeze applications down to -35 °C and for extremely heavy duty applications. www.igus.eu/CF29      





Control cables: e.g. chainflex® CF9.UL – for extreme stressing in outdoor applications with UL approval. www.igus.eu/CF9UL      



Shielded control cables: e.g. chainflex® CF10.UL – for extreme stressing in cold temperatures. www.igus.eu/CF10UL      



Motor cables: e.g. chainflex® CF38 – for extreme stressing. www.igus.eu/CF38   

... for e-chains®

... is the key for a long service life in energy chains®

- Savings due to different quality levels
- Solutions for long and short travels
- Always with 36 month guarantee*
- Clear service life data for every series
- Matched to the e-chain®

 www.chainflex.eu



Tested!

In the largest lab of its kind, igus® Cologne

For example: cold test



Objective: to determine the maximum service life of igus® chainflex® TPE cables at temperatures of -40°C.

Test setup: An igus® CF340 TPE cable was moved in an e-chain® in the igus® climate container at a travel of 7 m and a speed of 1.5 m/s at -40°C. Results: The test was ended after 3.7 million double strokes. The cable exhibits little or no wear and is fully functional.





Control cables: e.g. chainflex® CF98 – for highest demands with minimum radii, halogen-free and cold-flexible. www.igus.eu/CF98   



Single cores: e.g. chainflex® CF340 – for extreme stressing in small installation spaces. www.igus.eu/CF340   



FOC: e.g. chainflex® CFLG.2G. – gradient fibre optic cable for extreme stressing, with the smallest radii, indoor and outdoor applications. www.igus.eu/CFLG  



Bus cables: e.g. chainflex® CFBUS.060 – Profibus, Profinet, Ethernet, CAN-BUS cables for extremely dynamic loads with the smallest bend radii. www.igus.eu/CFBUS     

* 36 months or up to 10 million double strokes (5 million for cables of the chainflex® M family); whichever is first

chainflex® cables for ...

Bus cables for hanging applications up to 50 m

chainflex® bus cable CFSPECIAL.182 – Profibus/Ethernet cable

For increased tensile load. Solution for moving applications that go beyond the normal energy supply applications.

- For hanging applications up to 50 m
- For increased tensile load
- Storage and retrieval units, hanging control units and lifts

www.chainflex.eu/CFSP1



In the largest lab of its kind, igus® Cologne

Test 4428 – CFSPECIAL.182.045

Ethernet cable for extremely heavy duty use – flawless data transmission at 2919 N – 15,000% more than called for in the DIN standard.

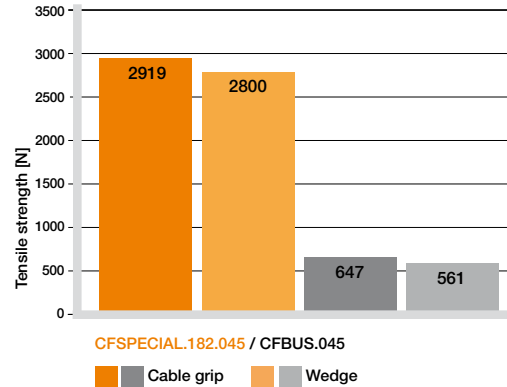

... every moving application

Savings up to 67% ... by custom solution ... with guarantee

chainflex® CF27.D



- For heaviest duty applications
- PUR outer jacket
- Shielded
- Oil resistant and coolant-resistant
- Flame retardant
- Hydrolysis and microbe-resistant
- PVC and halogen-free

www.chainflex.eu/CF27D

chainflex® CF887



- For flexing applications
- PVC outer jacket
- Shielded

www.chainflex.eu/CF887

Savings up to 71% ... through customised solution ... with guarantee

chainflex® CFBUS



- For heaviest duty applications
- TPE outer jacket
- Shielded
- Oil resistant
- Bio-oil-resistant
- Flame retardant
- Hydrolysis and microbe-resistant

www.chainflex.eu/CBUS

chainflex® CF888



- For flexing applications
- PVC outer jacket
- Shielded

www.chainflex.eu/CF888

i Save money with reliability and innovation ... 3 year igus® guarantee for every chainflex® cable.

Guarantee statements reduce risk plant engineering. With our unique igus® guarantee for ALL chainflex® cables, we are providing predictable security for 36 months, or up to 10 million double strokes (5 million double strokes for very cost-effective chainflex® M cables).

Guarantee
igus chainflex

36

month guarantee

Industrially harnessed ...



The 4,700 qm readychain® factory in Cologne



Cable processing



Harnessing



100% testing

readychain®: harnessed e-chainsystem® reduces installation time by 3-8 hrs.

1,600 systems produced per week in 12 readychain® factories around the world – assembly time optimised to increase your cash-flow. The largest factory for harnessed readychain® systems with 4,700 m² and 160 employees in Cologne.

- Eliminate storage costs for cables, e-chains® and connectors

- Cut turnaround times by half
- Flexibility when orders vary
- Reduce the number of suppliers and orders by 75%
- Minimise your machine downtime
- System guarantee – depending on the application

www.readychain.eu

... delivered ready to install ...

... 80% process costs ... 95% save time ...

Always the right harness for your application

Basic
e-chain® with fitted cables
and strain relief in the system
www.igus.eu/RCbasic

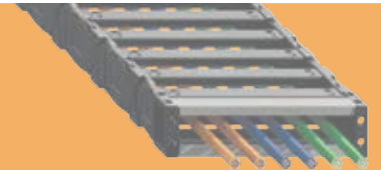

Standard
e-chain® with cables
and appropriate connectors
www.igus.eu/RCstandard



Preferred in the material flow industry:
Standard +
Pre-harnessed e-chainsystems®
with appropriate sheet-metal parts
www.igus.eu/RCstandard+



Premium
Ready to mount complete system
with transport rack
www.igus.eu/RCpremium



readychain® speed: Exchanged in seconds.

Plug & Work. The new readychain® speed makes connecting harnessed e-chains® easier than ever before. Completed in seconds – without tool. Connector and mounting bracket are combined into a single unit for the shortest possible downtime.

www.igus.eu/readychainspeed



Matching coupling

smart plastics products ...

Intelligent products predict their replacement date

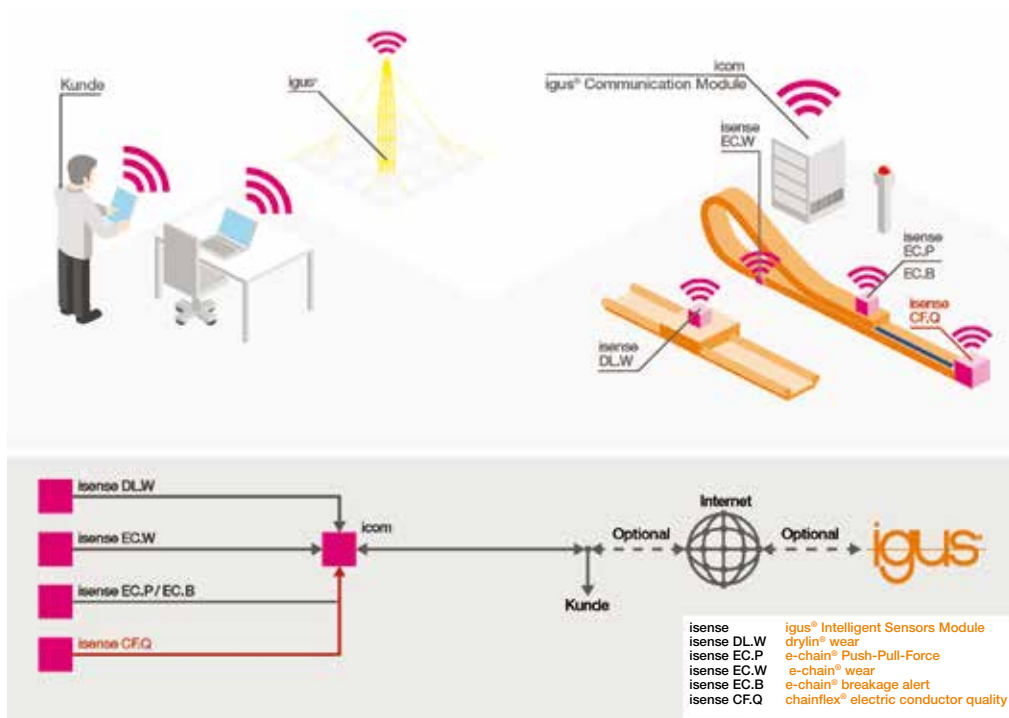

The intelligent functional principle.

The isense family of igus® products consists of various intelligent sensors and monitoring modules. They measure wear during the operation and alert the user early enough to plan a repair or an exchange. The igus® Communication Module (icom) makes the seamless integration into your IT infrastructure possible. This allows scenarios like the continuous monitoring or automatic triggering of in-house maintenance jobs. An optional connection with the igus® data centre widens the options: individual lifetime optimizations and faster operational processes like automatic ordering of external maintenance crews or ordering of spare parts. These include maintenance commissioning or spare parts ordering. Thanks to smart plastics your equipment runs continuously and your maintenance costs go down. Improved safety is an additional benefit.

Cost reduction and risk minimisation due to:

- Prevention of downtime
- Predictable maintenance intervals due to preventive maintenance
- Reduction of maintenance costs due to timely replacement

www.igus.eu/industry40

... failsafe guarantee

e-chains®, cables, linear bearings are "smart plastics"

Based on the same principle isense – intelligent sensor – in or around the product, and icom communication module, igus® brings three intelligent products to the industrial market. The new intelligent e-chains® can do the following:

- Increased plant reliability and availability
- Possibility of remote scanning via GSM/Internet

www.igus.eu/smart-echain

Intelligent e-chain®

The wear status of the intelligent e-chain® is continuously monitored by an integrated sensor. Is the wear critical to the function, the chip alarms the system. A repair or replacement can be planned ahead of time and the downtime is eliminated or greatly reduced.

www.igus.eu/smart-echain

- Can be retrofitted in existing applications
- Integration into your maintenance procedures
- Avoid unplanned machine downtime
- Can be combined with other igus® isense products as EC.P, EC.B
- Prevention of unplanned down-times
- Optimal machine availability



Intelligent chainflex® cables

Additional conductors are used for a continuous monitoring of the electric performance and inform early of a near failure. If the conductivity falls below a defined threshold, a signal is sent immediately and the cable can then be replaced in the framework of scheduled maintenance work without any extra effort or downtime.

www.igus.eu/smart-cable



Intelligent drylin® guide system

A plastic element that has an integrated sensor and can be retrofitted communicates the wear. When a failure becomes imminent, the user receives this information and prevents unplanned downtime and cost with timely planned maintenance.

www.igus.eu/smart-drylin



igus® dry-tech® plain bearings 100% lubrication-free

Lubrication-free and resistant to dirt

Wear resistant with heavy load

Maintenance-free and cost-effective

Loads up to 200 MPa

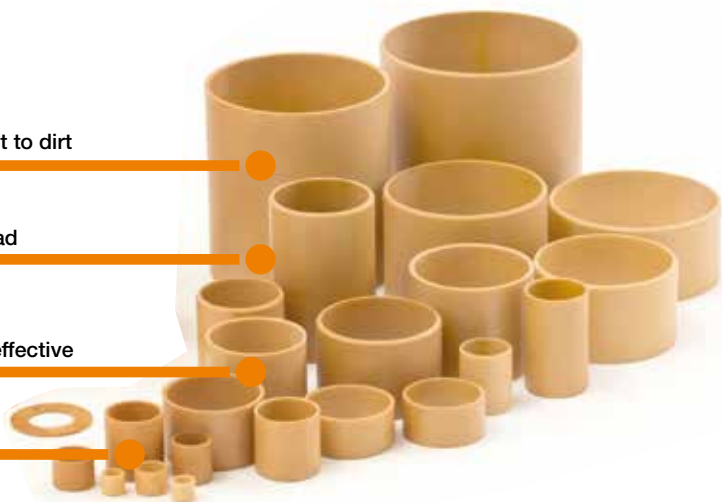

igidur® plain bearings

igidur® plastic bearings from igus® are lubrication-free, maintenance-free, cost-effective and versatile. They always offer a solution – either from the catalogue range or as custom-made plain bearing special solution – from a quantity of 1 piece!

- 50 different materials – delivered from stock
- Corrosion-resistant
- Resistant to dirt
- High compressive strengths
- Low coefficients of friction
- High wear resistance

www.igus.eu/igidur



igidur® G – the classic all-rounder
Universal bearing for applications with medium to high loads.

www.igus.eu/g



igidur® J – the versatile endurance runner
The perfect combination of wear resistant plain bearings for medium loads and optimum coefficients of friction.

www.igus.eu/j



igidur® Q2 – the durable heavy-duty bearing
Plain bearing solution for heavy duty pivoting applications and extreme conditions.

www.igus.eu/q2



igidur® TX1 – the high load bearing up to 200 MPa static and 140 MPa dynamic
Outstanding rigidity and durability especially under high radial loads during pivoting operations.

www.igus.eu/tx1

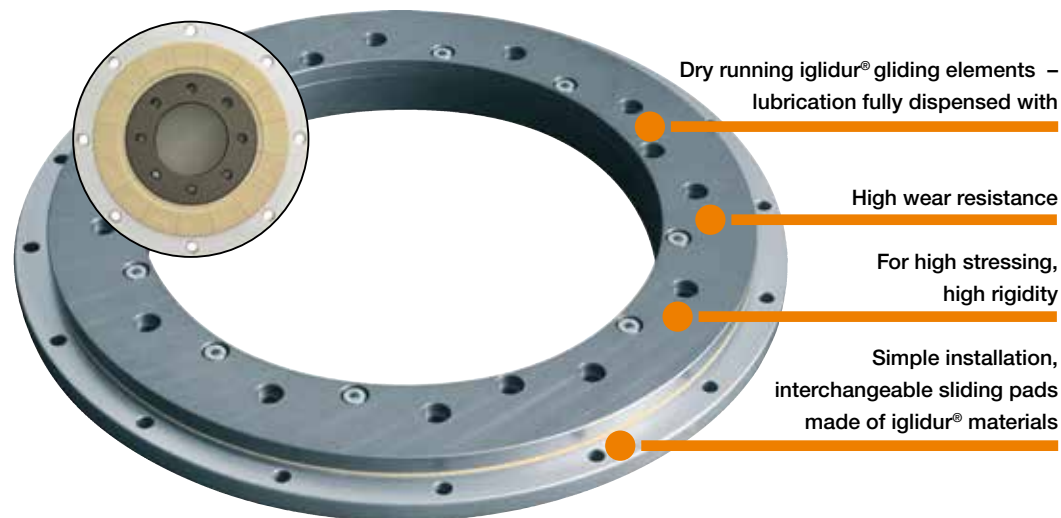

Dry running iglidur® gliding elements – lubrication fully dispensed with

High wear resistance

For high stressing, high rigidity

Simple installation, interchangeable sliding pads made of iglidur® materials

Polymer slewing ring bearing – iglidur® PRT

igidur® PRT is a low priced, low maintenance slewing ring bearing with tribo-optimised iglidur® polymer sliding pads. The sliding elements operate completely without maintenance and lubrication. The housing components of the slewing ring bearings are made from aluminium, and the counter-partners of the bearings are hard-anodised. All fastening screws are made of stainless steel.

- Maintenance-free, lubrication-free
- Ready-to-install solution
- Robust and corrosion-resistant
- Optionally usable up to 180 °C
- For low to medium surface speeds

www.igus.eu/igidurPRT



Slewing ring bearing - design 01
Slewing ring with high stiffness, useable up to +180 °C, high chemical resistance.



Slewing ring bearing with gear teeth
For all 6 sizes of the design 01, 4 standards are available for the toothing of the outer ring.



Slewing ring bearing - design 02.
Slewing ring with extremely low weight. Outer ring made of anodised aluminium or stainless steel (V4A).



Universal gliding pads
Using the flexible iglidur® PRT universal gliding elements, large, plain bearing supported slewing ring systems can be custom fabricated based on design 01.

Gliding instead of rolling ...

drylin® W – modular linear construction kit

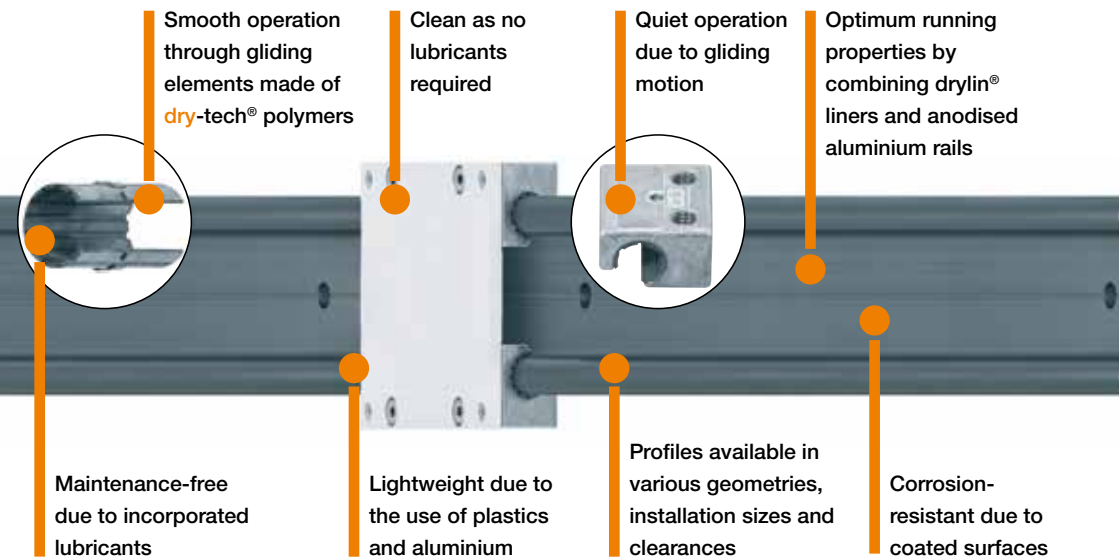

Smooth operation through gliding elements made of **dry-tech®** polymers

Clean as no lubricants required

Quiet operation due to gliding motion

Optimum running properties by combining drylin® liners and anodised aluminium rails

Maintenance-free due to incorporated lubricants

Lightweight due to the use of plastics and aluminium

Profiles available in various geometries, installation sizes and clearances

Corrosion-resistant due to coated surfaces

... drylin® linear system

Lubrication-free linear technology – drylin®.

drylin® is a product range of lubrication-free linear plain bearings based on the principle of sliding instead of rolling. Tribologically optimised iglidur® high performance polymers are used as sliding surfaces. The drylin® linear systems traverse in dry operation and are maintenance-free. Linear guides on rails or round shafts are available. The drylin® drive technology can supply ready-to-connect systems with lead screw drives or toothed belt drives, with or without motor. The focus is on the ruggedness and insensitivity to influences such as dirt, water, chemicals, heat or shock loads, as well as the freedom from maintenance and lubrication.

- Resistant to dirt due to dry operation
- Resistant to impacts and vibrations
- High static load capacity
- Suited for short-stroke applications
- High speeds possible up to 10 m/s and accelerations up to 100 G
- Low magnetism



www.igus.eu/drylin

Other maintenance-free drylin® linear technology solutions.



drylin® N

- Flat guides in 4 sizes
- Low profile installation heights from 6 to 12 mm
- Rail widths from 17 mm to 80 mm
- Many carriage options – also with preload
- Lightweight

www.igus.eu/drylinN



drylin® T

- Rail guides dimensionally equal to ball guides
- Adjustable bearing clearance
- Automatic clearance adjustment
- High static load capacity
- Service life up to 50,000 km
- Low vibration and quiet

www.igus.eu/drylinT



drylin® R

- Shaft guides dimensionally equal to recirculating ball bearing system
- For all shaft materials
- Lightweight
- Replaceable liners
- Linear adapter made from solid plastic or aluminium

www.igus.eu/drylinR



drylin® W

- Curved rails
- Resistant to dirt due to dry operation
- Angular rail with floating bearing function for corner mounting
- Special profile solutions

www.igus.eu/drylinSD



drylin® WJRM

- Plain bearing plastic rollers
- Low driving force required, coefficient of friction: 0.04–0.05 μ
- Cost-effective roller bearing
- Use with 7 linear profile rails

www.igus.eu/drylinWJRM

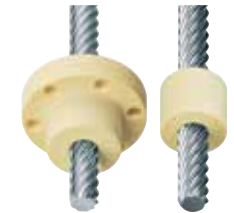

drylin® lead screw technology

- Systems consisting of lead screw nut and lead screw
- dryspin® high-helix threads, efficient and long-lasting
- Self-locking trapezoidal and metric threads

www.igus.eu/drylinSD

drylin® drive technology

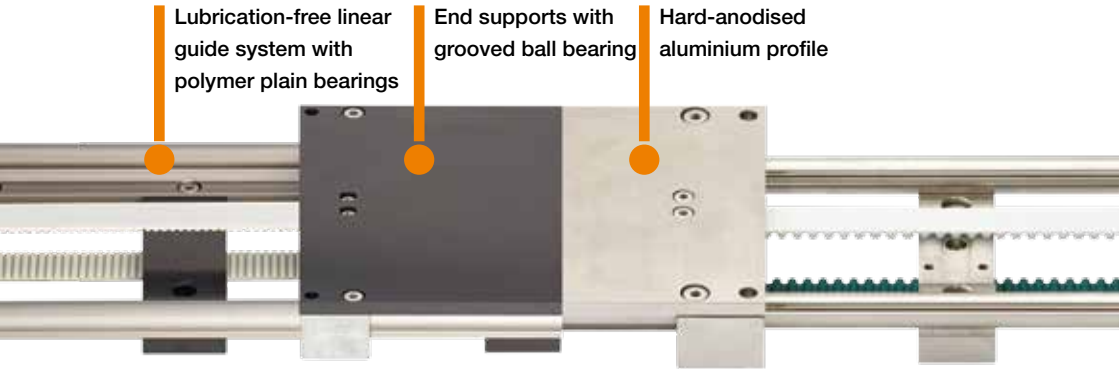

Lubrication-free linear guide system with polymer plain bearings

End supports with grooved ball bearing

Hard-anodised aluminium profile

drylin® ZLW toothed belt axis

The use of polymer plain bearings in all moving parts makes the toothed belt axis 100% maintenance-free and lubrication-free. Avoidance of lubricant also means a high level of insensitivity to dirt since dirt particles do not stick to the moving parts. The axis "offers" a high degree of robustness in many applications. Depending on the application area and requirement, you can choose between Basic and Standard.

- Fast positioning of small loads
- Quiet operation
- Slim design
- Underwater use with UW-belt
- Cost-effective solution as basic version
- Long-term use

www.igus.eu/drylinZLW

Further maintenance-free drylin® drive technology systems



drylin® E drive technology

- Linear axes with stepper motors/ DC motors
- Fail-safe due to the use of encoders and initiators
- Can be combined for linear robot configurations

www.igus.eu/drylinE

drylin® E motors

- Linear axes with stepper motors/ DC motors
- Fail-safe due to the use of encoders and initiators
- Can be combined for linear robot configurations

www.igus.eu/drylinE

drylin® E linear robots

- Driven via lead screw, belt drive, rack and pinion
- Gantry systems from stock
- Defined stroke length
- Base drylin® toothed belt axis ZLW, cantilever axis GRW

www.igus.eu/drylinE

xiros® plastic ball bearings



FDA-compliant

Predictable service life

Many other designs

Dry running, washable

Balls made of glass or stainless steel

Up to 150°C continuous working temperature

xiros® ball bearing for the material handling – ball bearing and castor in one

According to the principle of "handling without grease", xiros® polymer ball bearings offer an innovative solution for the challenges of modern material handling. Its lubrication-free operation allows it to be used even in sensitive areas and guarantees a largely maintenance-free operation. The excellent coefficients of friction ensure safe and trouble-free operation, their predictable service life provide planning reliability and a minimum of downtime. Since they are also light and

cost-effective, xiros® polymer ball bearings ensure an efficient conveyor system that is at once lubrication-free, simple and cost-effective.

- Lubrication and maintenance-free
- High corrosion resistance
- For temperatures up to +150°C
- High media resistance, washable, non-magnetic
- Low weight

www.igus.eu/xiros



In overhead conveyor technology, the xiros® ball bearings can be used directly as castors

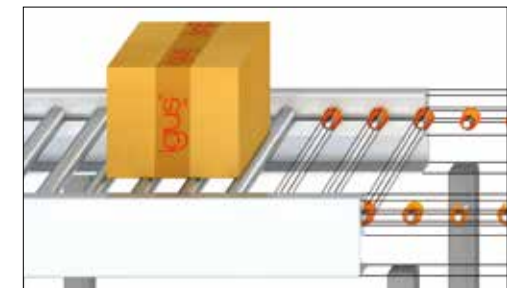

Ready-to-install system solutions from stock or customised roller-carrier systems on request.

Balance of misalignments

Maintenance-free igubal® pillow block bearings and flange bearings



igubal® pillow block bearings

Easy to install bearing units in different designs

- Compensation of misalignment errors
- High strength under impact loads

www.igus.eu/pillowblocks

igubal® flange bearings

For the bearing of shaft ends or shaft extensions.

- Low installation space and low weight
- 2 or 4 mounting holes

www.igus.eu/igubal-flange



For free design

iglidur® bar stock optimised for friction and wear coefficients



Special parts made of tribo-plastics according to customer requirement

speedimold is very simple! Special solutions manufactured exactly as you need it. virtually anything is possible with our iglidur materials, "off the shelf" or "custom solutions" everything is maintenance and lubrication free. Choose from 8 iglidur® tribo-plastic materials iglidur® G, iglidur® J, iglidur® W300,

iglidur® X, iglidur® M250, iglidur® P, iglidur® A180, iglidur® H2 and igumid G. Available in 1 to 10 days depending on the complexity with no minimum order value.

www.igus.eu/speedimold



Simply cut and stick tribo-tape

- Suitable for a lining surfaces and shapes where wear is an issue
- Easy to cut and glue
- Less space required
- Optional self-adhesive back

www.igus.eu/tribotape

For free design – iglidur® bar stock

- iglidur® materials as round bars, tubes and plates
- Currently 26 iglidur® materials to choose from
- Cut to required size without offcut removal
- Mechanical processing from a batch size of 1
- Maintenance-free and calculable

www.igus.eu/barstock



The website for your industry.

Visit our industry web pages for more information, products, application examples and useful online-tools.

www.igus.eu/materialhandling

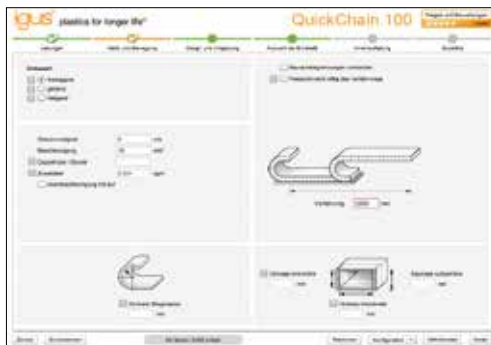
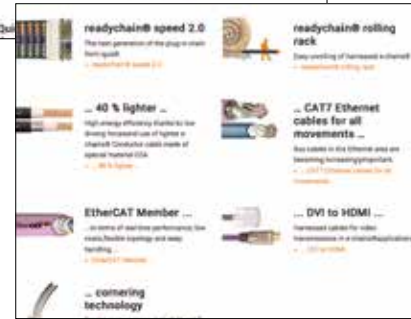
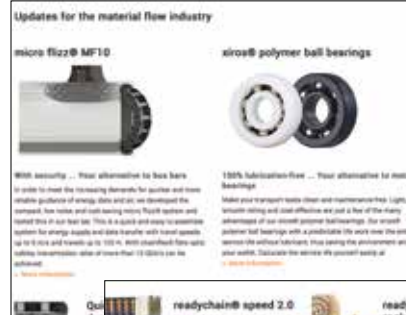

Quickly find and configure products and calculate service life – all online.

Using our online product finders, you can find the right igus® product and get a service life prediction.

www.igus.eu/online



igus® delivery service

Over 97% availability of all catalogue parts - no need for you to stock

- Over 100,000 products from stock
- No minimum order
- No surcharges for small quantities
- No costs for cutting cables
- No packaging costs

www.igus.eu/triflex



The igus® installation service

Ensure professional installation and avoid downtimes and additional costs – with the igus® e-chainsystem® installation service.

- Products and services from a single source – with low logistics costs for you
- igus® system guarantee, customised for each application

www.igus.eu/assemblyservice



The igus® lab

The industry's largest test lab (2,750m²) conducts more than two billion test cycles per year on a total of 107 test rigs.

- Extensive test databases
- Customised tests upon request

www.igus.eu/test

igus® motion plastics®

One vision has been driving us for more than 50 years – motion plastics®: moving parts made of plastic that cost less and last longer. Our core technology consists of tribo-polymers – high-performance plastics, which we have optimised for friction and wear. The technology has made us into a world-wide leader for developing and manufacturing energy supply systems and plain bearings.



/9001:2008 /16949:2009

igus® is certified in accordance with ISO 9001:2008 and ISO/TS 16949:2009 in the field of energy supply systems, cables and harnessing, as well as plastic plain bearings.

/newsletter

Free of charge! Discover more about the latest trends and innovations from igus® motion plastics® world. Many exciting applications and videos, even from your industry.

Register here: www.igus.eu/newsletter

/contact

Your contact person for your industry and your country: www.igus.eu/contact

igus®

igus® GmbH
Spicher Str. 1a
51147 Cologne
Phone +49-2203 9649-0
Fax +49-2203 9649-222
info@igus.de
www.igus.eu

© 2017 igus® GmbH

Published by igus® GmbH, Germany
MAT0071419.20 Issue 03/2017
Subject to technical alterations.

