

iglidur® UW – The Underwater Specialist



For underwater applications

For fast and constant motion

iglidur® UW

Phone +49 - 22 03 - 96 49-145
Fax +49 - 22 03 - 96 49-334

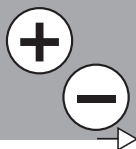



iglidur® UW | The Underwater Specialist

The best iglidur® polymer for underwater applications. Extremely wear resistant under water, tested, maintenance-free. With a predictable lifetime this is the polymer of choice for pumping applications.

iglidur® UW

2 styles
> 16 Dimensions
Ø 3–20 mm



Phone +49 - 22 03 - 96 49-145
Fax +49 - 22 03 - 96 49-334

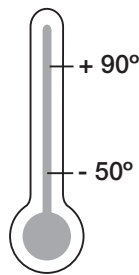

igus® GmbH
51147 Cologne

Price index



The Underwater Specialist



When to use iglidur® UW plain bearings:

- For high speeds
- For low loads
- For temperatures up to 90°C
- Best iglidur® polymer for underwater applications
- Extremely wear resistant underwater
- Tested, maintenance-free and predictable service life
- Ideal for pump applications



When not to use iglidur® UW plain bearings:

- When bearings only need to be used underwater for a short time
▶ iglidur® H370 (chapter 15)
- When temperatures are continuously higher than 90°C
▶ iglidur® UW500 (chapter 30)
- When high loads are required
▶ iglidur® H370 (chapter 15), UW500 (chapter 30), X (chapter 6)

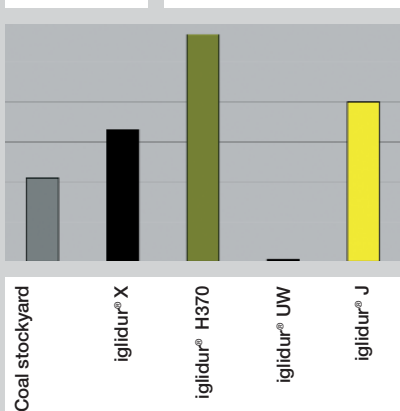

Picture 20.1: wear under water rotating, p = 0.25 MPa, v = 1 m/s shaft X 90, test duration: 10,000 min.

Material Table

General Properties	Unit	iglidur® UW	Testing Method
Density	g/cm ³	1,52	
Colour		Black	
Max. moisture absorption at 23°C / 50% r.F.	% weight	0,2	DIN 53495
Max. water absorption ³⁾	% weight	0,8	
Coefficient of friction, dynamic against steel	μ	0,22 - 0,5	
p x v value, max. (dry)	MPa x m/s	0,30	

Mechanical Properties

Modulus of elasticity	MPa	9.600	DIN 53457
Tensile strength 20°C	MPa	90	DIN 53452
Compressive strength	MPa	n.d.	
Max. recommended surface pressure (20°C)	MPa	40	
Shore D hardness		78	DIN 53505

Physical and Thermal Properties

Max. long term application temperature	°C	90	
Max. short term application temperature	°C	110	
Max. short term ambient temperature ¹⁾	°C	140	
Min. application temperature	°C	-50	
Thermal conductivity	W/m x K	0,60	ASTM C 177
Coefficient of thermal expansion (at 23°C)	K ⁻¹ x 10 ⁻⁵	6	DIN 53752

Electrical Properties²⁾

Specific volume resistance	Ωcm	< 10 ⁵	DIN IEC 93
Surface resistance	Ω	< 10 ⁵	DIN 53482

¹⁾ Without additional load, no sliding movement; relaxation possible

²⁾ The good conductivity of this plastic material under certain circumstances can favour the generation of corrosion on the metallic contact component.

³⁾ With respect to the use of the material in direct contact with water, it has to be pointed out that all results have been attained under laboratory conditions DW (demineralised water). We therefore recommend custom-designed tests under real application conditions.

Table 20.1: Material Data

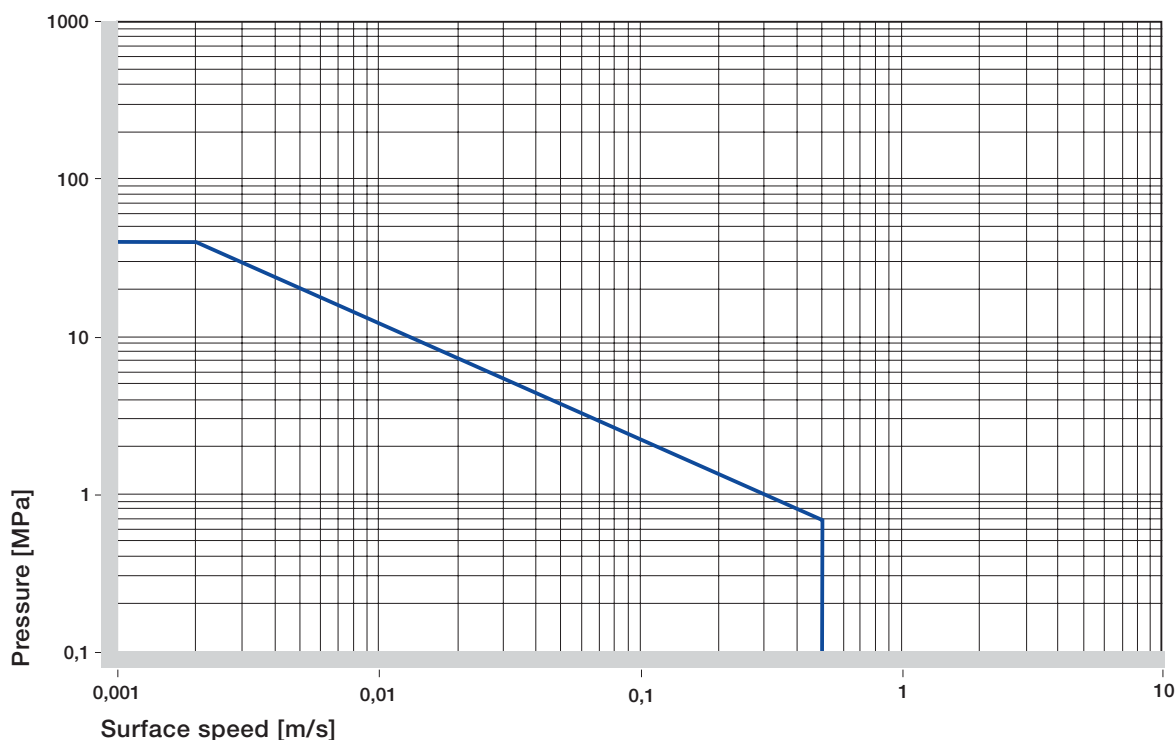

Graph 20.1: Permissible p x v values for iglidur® UW with a wall thickness of 1 mm running dry against a steel shaft at 20°C, mounted in a steel housing

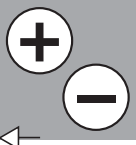

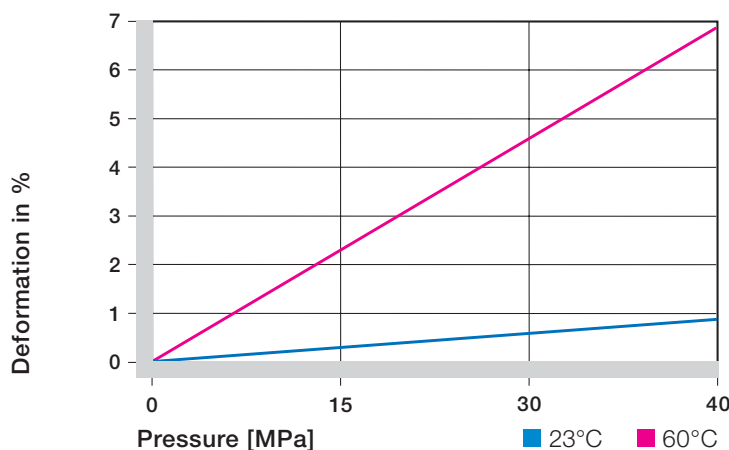

Graph 20.2: Deformation under pressure and temperature

m/s	Rotating	Oscillating	Linear
Continuous	0,5	0,4	2
Short term	1,5	1,1	3

Table 20.2: Maximum surface speeds

igidur® UW	Application Temperature
Minimum	- 50 °C
Max. long term	+ 90 °C
Max. short term	+ 110 °C

Table 20.3: Temperature limits for iglidur® UW

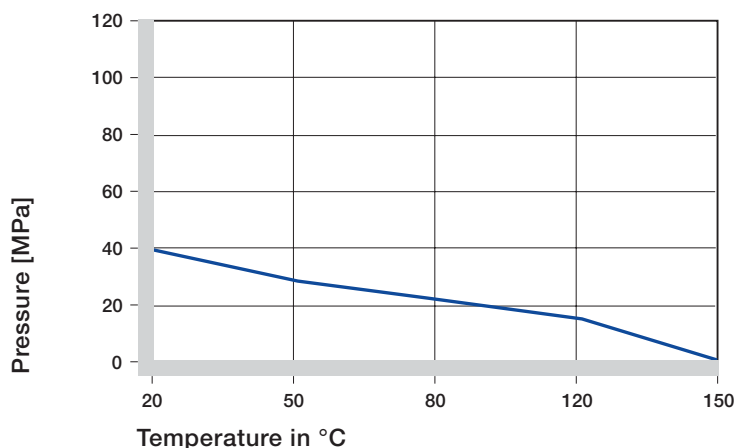

Graph 20.3: Recommended maximum surface pressure of iglidur® UW as a function of temperature

igidur® UW was developed for underwater applications at temperatures well below 100°C. For application temperatures above this limit, the plain bearings made from iglidur® UW500 (chapter 30) are provided. Even though iglidur® UW was developed for application in fluids, it is also qualified for “dry” applications. This is particularly important with regard to applications with dry run as well as using fluids. In practice, this type of application is often seen.

Throughout this chapter, when the properties of iglidur® UW are described, the conditions are running dry unless otherwise stated.

Surface Pressure

Graph 20.3 shows the permissible bearing loads at the respective temperatures. It can be said that iglidur® UW plain bearings are not very suitable for high loads. Normally in underwater applications there is no question of high loads being present. It is also important to note that the wear rate increases significantly from loads of 5 MPa.

Graph 20.2

Surface Pressure, page 1.18

Permissible Surface Speeds

igidur UW shows good results when running dry as well as in fluids. When running underwater the bearing is lubricated hydrodynamically, and surface speeds in excess of 2 m/s can be achieved.

When running dry, short term surface speeds up to 1.5 m/s can be achieved.

Surface Speed, page 1.20

p x v value, page 1.22

Temperatures

As stated earlier, iglidur® UW plain bearings are recommended for the low temperature range. The bearing temperature can be up to 90 degrees, although the frictional heat must also be considered here, especially when running dry.

In underwater applications, the fluid aids heat dissipation, so in this case the temperature of the fluid is of greater importance.

- ☑ Graphs 20.3 and 20.6
- ▶ Application Temperatures, page 1.23

Friction and Wear

When running underwater, the friction coefficient will be considerably lower than when running dry. At low loads when running dry, the coefficient of friction can increase to 0.4, but at higher loads this decreases to 0.1. The shaft should not be too smooth to avoid a high adhesion effect and thus generate an increase in friction. For information regarding the surface finish of shafts when running underwater, please contact us.

- ☑ Graphs 20.5 to 20.7
- ▶ Coefficients of Friction and Surfaces, page 1.25
- ▶ Wear Resistance, page 1.26

iglidur® UW	Dry	Grease	Oil	Water
C.o.f. [μ]	0,22 - 0,5	0,09	0,04	0,04

Table 20.4: Coefficient of friction of iglidur® UW against steel (Ra = 1 μm, 50 HRC)

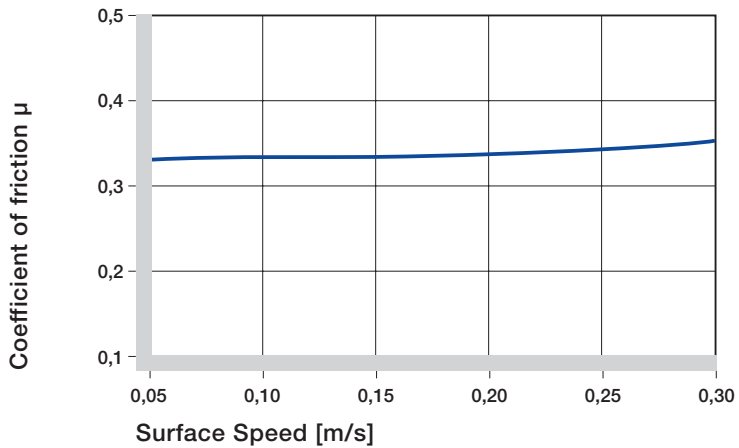

Graph 20.4: Coefficients of friction of iglidur® UW as a function of the surface speed, p = 0.75 MPa

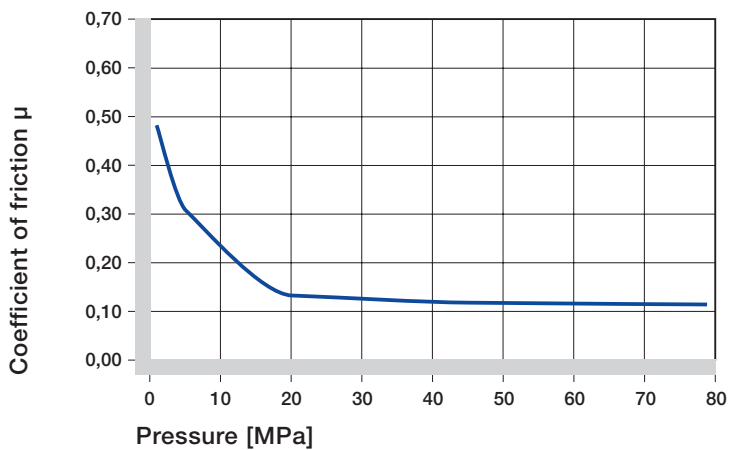

Graph 20.5: Coefficients of friction of iglidur® UW as a function of the pressure, v = 0.01 m/s

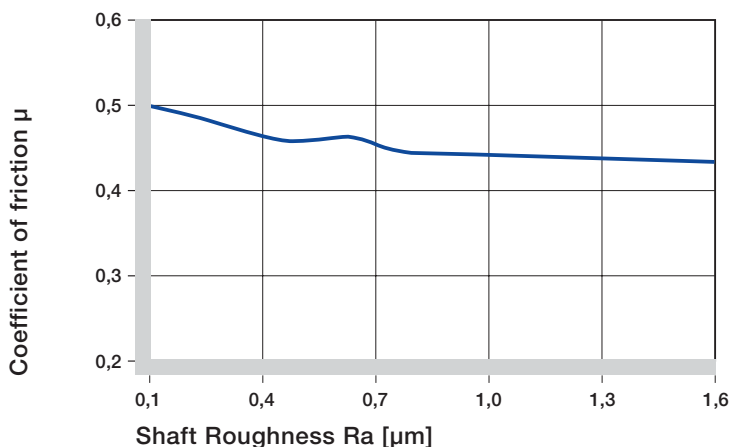

Graph 20.6: Coefficients of friction of iglidur® UW as a function of the shaft surface (Cf53 hardened and ground steel)

iglidur® UW

Phone +49 - 22 03 - 96 49-145
Fax +49 - 22 03 - 96 49-334

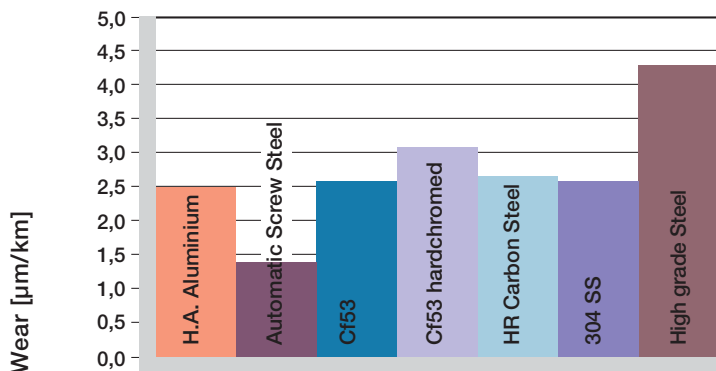

Shaft materials

Graph 20.7: Wear of iglidur® UW, rotating applications with different shaft materials, $p = 0.75 \text{ MPa}$, $v = 0.5 \text{ m/s}$

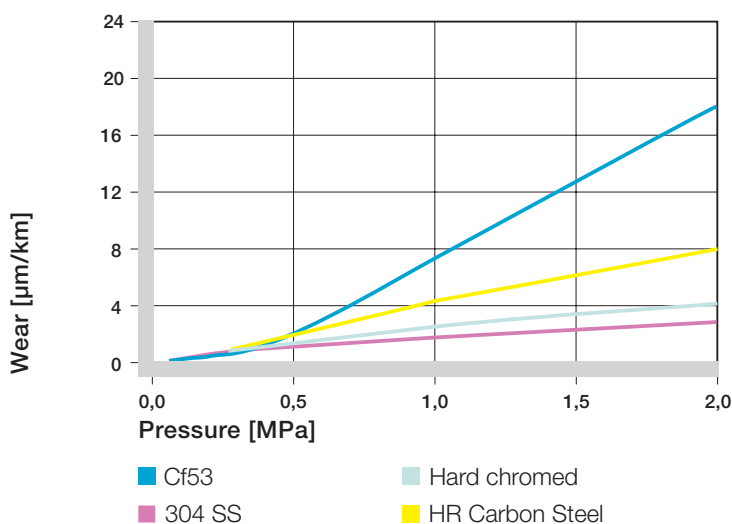

Graph 20.8: Wear of iglidur® UW with different shaft materials in rotational applications

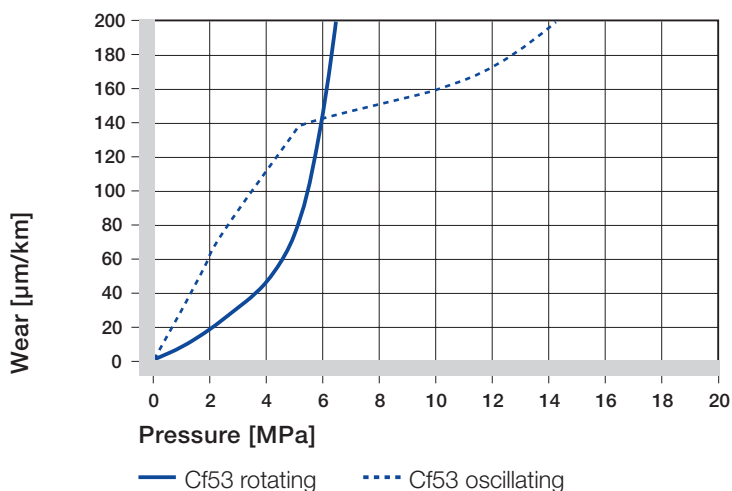

Graph 20.9: Wear for rotating and oscillating applications as a function of the pressure (Cf53 hardened and ground steel shaft)

Shaft Materials

The effect of the type of shaft material used with iglidur® UW plain bearings at low loads is small, as shown in graph 20.7. However, Graph 20.8 shows that the shaft material selection becomes more significant at higher loads.

For questions concerning a specific running surface, please contact your igus® consultant.

- Graphs 20.8 to 20.10
- Shaft Materials, page 1.28

Installation Tolerances

iglidur® UW plain bearings are standard bearings for shafts with h tolerance (h9 recommended at least).

designed for pressfit into a housing machined to a H7 tolerance. After being assembled into a nominal size housing, the inner diameter of the bearings is automatically adjusted to an E10 tolerance.

- Testing Methods, page 1.32/1.33

Chemical Resistance

iglidur® UW plain bearings are resistant to diluted alkalines and very weak acids, as well as to solvents and all types of lubricants. The moisture absorption of iglidur® UW plain bearings is approximately 0.2% in standard atmosphere. The saturation in water is 0.8%. These values are so low that considering expansion by moisture absorption is only required under extreme conditions.

- Graph 20.10
- Chemical Table, page 70.1

Radiation Resistance

Plain bearings of iglidur® UW are radiation resistant to a radiation intensity of $3 \times 10^2 \text{ Gy}$.



UV Resistance

iglidur® UW plain bearings are resistant to the impact of UV radiation.

Vacuum

Applications in a vacuum are only possible to a limited extent. Only dehumidified bearings of iglidur® UW should be tested in a vacuum.

Electrical Properties

iglidur® UW plain bearings are conductive.

Diameter d1 [mm]	Shaft h9 [mm]	iglidur® UW E10 [mm]
up to 3	0 - 0,025	+0,014 + 0,054
> 3 to 6	0 - 0,030	+0,020 + 0,068
> 6 to 10	0 - 0,036	+0,025 + 0,083
> 10 to 18	0 - 0,043	+0,032 + 0,102
> 18 to 30	0 - 0,052	+0,040 + 0,124
> 30 to 50	0 - 0,062	+0,050 + 0,150

Table 20.5: Essential tolerances for iglidur® UW plain bearings according to ISO 3547-1 after pressfit

Medium	Resistance
Alcohol	+
Hydrocarbons	+
Greases, oils without additives	+
Fuels	+
Diluted acids	0 to -
Strong acids	-
Diluted alkalines	+
Strong alkalines	+ to 0

Table 20.6: Chemical resistance of iglidur® UW – detailed list, page 70.1

+ resistant 0 conditionally resistant - not resistant

All data given at room temperature [20°C]

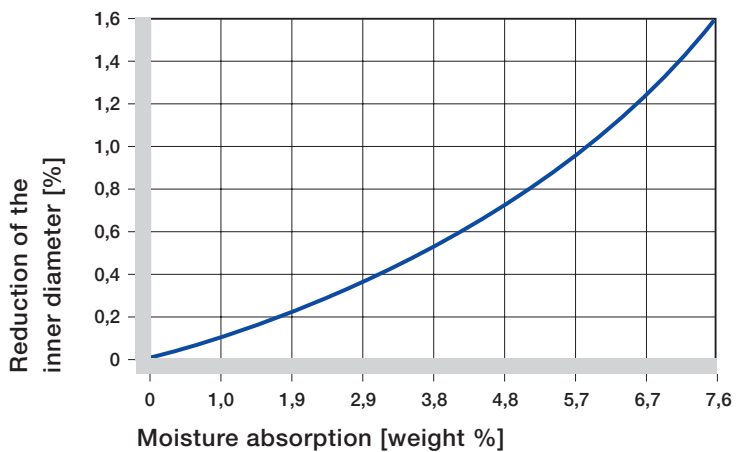

Graph 20.10: Effect of moisture absorption on iglidur® UW plain bearings

iglidur® UW	
Specific volume resistance	< 10 ⁵ Ωcm
Surface resistance	< 10 ⁵ Ω

Table 20.7: Electrical properties of iglidur® UW

iglidur® UW

Phone +49 - 22 03 - 96 49-145
Fax +49 - 22 03 - 96 49-334





iglidur® UW | Sleeve Bearing | mm

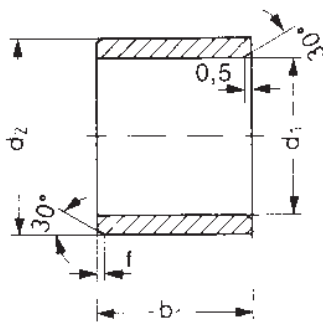

Data in mm
Structure - part no.
UW S M-0304-05

- b1
- d2
- d1
- Metric
- Type
- Material

Chamfer in relation to the d1

d1 [mm]:	Ø 1-6	Ø 6-12	Ø 12-30	Ø > 30
f [mm]:	0,3	0,5	0,8	1,2

Dimensions according to ISO 3547-1 and special dimensions

Part Number	d1	d1-Tolerance*	d2	b1
				h13
UWSM-0304-05	3,0	+0,014 +0,054	4,5	5,0
UWSM-0405-06	4,0	+0,020 +0,068	5,5	6,0
UWSM-0507-08	5,0	+0,025 +0,083	7,0	8,0
UWSM-0608-08	6,0	+0,025 +0,083	8,0	8,0
UWSM-0810-10	8,0	+0,032 +0,102	10,0	10,0
UWSM-1012-10	10,0	+0,032 +0,102	12,0	10,0
UWSM-1214-12	12,0	+0,032 +0,102	14,0	12,0

*after pressfit. Testing methods ► page 1.32/1.33

mm
iglidur® UW
Phone +49 - 22 03 - 96 49-145
Fax +49 - 22 03 - 96 49-334

iglus® GmbH
51147 Cologne

iglidur® UW | Flange Bearing | mm

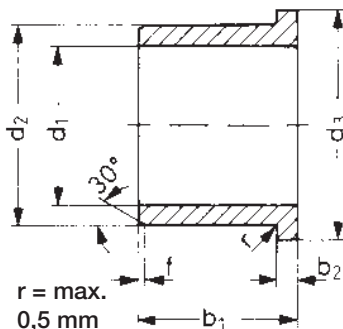

Data in mm
Structure - part no.
UW F M-0304-05

- b1
- d2
- d1
- Metric
- Type
- Material

Chamfer in relation to the d1

d1 [mm]:	Ø 1-6	Ø 6-12	Ø 12-30	Ø > 30
f [mm]:	0,3	0,5	0,8	1,2

Dimensions according to ISO 3547-1 and special dimensions

Part Number	d1	d1-Tolerance*	d2	d3	b1	b2
				d13	h13	-0,14
UWFM-0304-05	3,0	+0,020 +0,068	4,5	7,5	5	0,75
UWFM-0405-06	4,0	+0,020 +0,068	5,5	9,5	6	0,75
UWFM-0507-05	5,0	+0,025 +0,083	7,0	11,0	5	1
UWFM-0608-06	6,0	+0,040 +0,130	8,0	12,0	6	1
UWFM-0810-10	8,0	+0,025 +0,083	10,0	15,0	10	1
UWFM-1012-10	10,0	+0,032 +0,102	12,0	18,0	10	1
UWFM-1214-12	12,0	+0,032 +0,102	14,0	20,0	12	1
UWFM-1618-17	16,0	+0,032 +0,102	18,0	24,0	17	1
UWFM-2023-21	20,0	+0,040 +0,124	23,0	30,0	21,5	1,5

*after pressfit. Testing methods ► page 1.32/1.33

Internet www.igus.de
E-mail info@igus.de